



Connectors > Connector Accessories > Connector Backshells



Connector Backshell Product Style: **Unscreened**

Connector Backshell Product Type: **Backshell Extenders**

Cable Entry Diameter: **30.48 mm [ 1.2 in ]**

Primary Product Material: **Glassfiber Filled Thermoplastic**

Body Orientation: **Straight**

## Features

### Product Type Features

Connector Backshell Product Style	Unscreened
Connector Backshell Product Type	Backshell Extenders

### Body Features

Primary Product Color	Black
Primary Product Material	Glassfiber Filled Thermoplastic

### Mechanical Attachment

Thread Size	PG21
-------------	------

### Housing Features

Body Orientation	Straight
Compatible With Connector Shape	Circular

### Dimensions

Cable Entry Diameter	30.48 mm[1.2 in]
----------------------	------------------

### Operation/Application

Compatible With Connector Shell Size	23
--------------------------------------	----

### Industry Standards

UL Flammability Rating	UL 94V-1
------------------------	----------

### Packaging Features

Packaging Method	Carton
Packaging Quantity	20

### Product Compliance

[For compliance documentation, visit the product page on TE.com>](#)

EU RoHS Directive 2011/65/EU	Compliant
EU ELV Directive 2000/53/EC	Compliant
China RoHS 2 Directive MIIT Order No 32, 2016	No Restricted Materials Above Threshold
EU REACH Regulation (EC) No. 1907/2006	Current ECHA Candidate List: JAN 2025 (247) Candidate List Declared Against: JUNE 2024 (241) Does not contain REACH SVHC
Halogen Content	Low Halogen - Br, Cl, F, I < 900 ppm per homogenous material. Also BFR/CFR/PVC Free
Solder Process Capability	Not applicable for solder process capability

#### Product Compliance Disclaimer

This information is provided based on reasonable inquiry of our suppliers and represents our current actual knowledge based on the information they provided. This information is subject to change. The part numbers that TE has identified as EU RoHS compliant have a maximum concentration of 0.1% by weight in homogenous materials for lead, hexavalent chromium, mercury, PBB, PBDE, DBP, BBP, DEHP, DIBP, and 0.01% for cadmium, or qualify for an exemption to these limits as defined in the Annexes of Directive 2011/65/EU (RoHS2). Finished electrical and electronic equipment products will be CE marked as required by Directive 2011/65/EU. Components may not be CE marked. Additionally, the part numbers that TE has identified as EU ELV compliant have a maximum concentration of 0.1% by weight in homogenous materials for lead, hexavalent chromium, and mercury, and 0.01% for cadmium, or qualify for an exemption to these limits as defined in the Annexes of Directive 2000/53/EC (ELV). Regarding the REACH Regulation, the information TE provides on SVHC in articles for this part number is based on the latest European Chemicals Agency (ECHA) 'Guidance on requirements for substances in articles' posted at this URL: <https://echa.europa.eu/guidance-documents/guidance-on-reach>

### Compatible Parts



### Also in the Series | AMP Circular Plastic Connectors

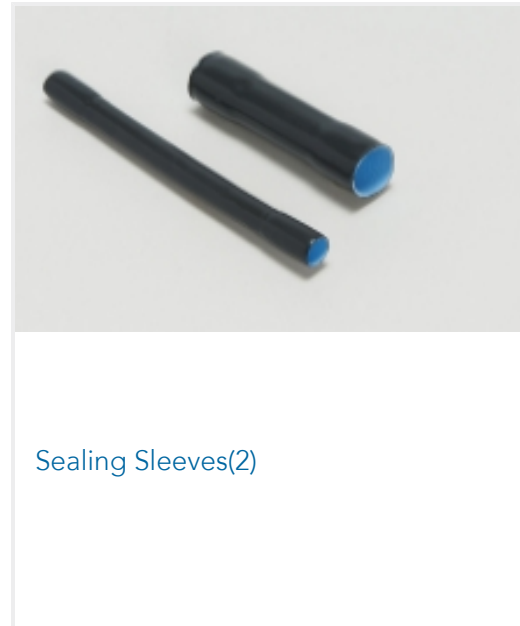
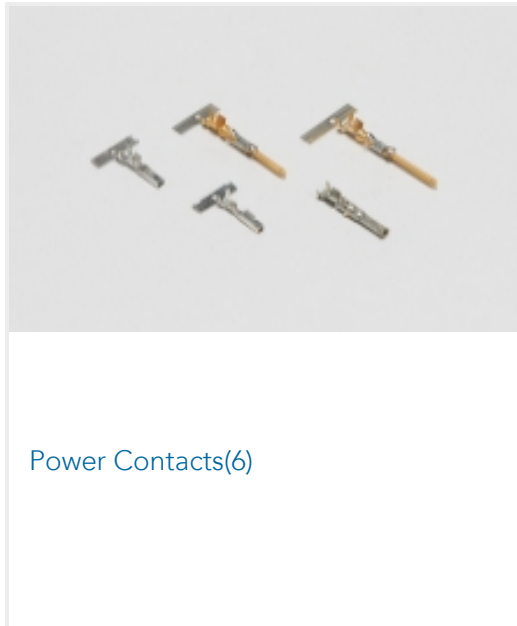
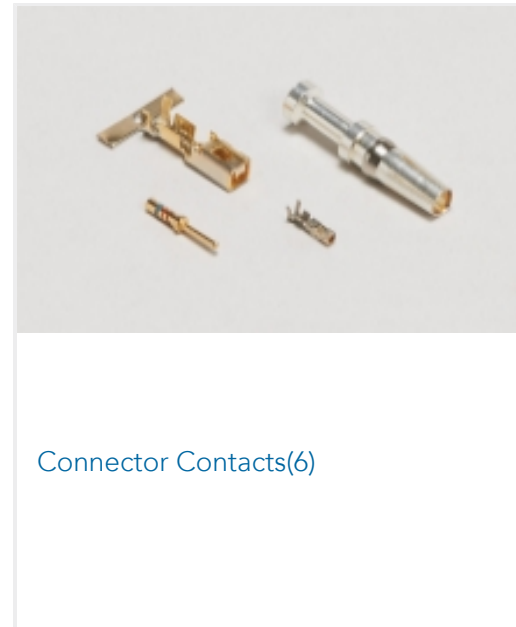
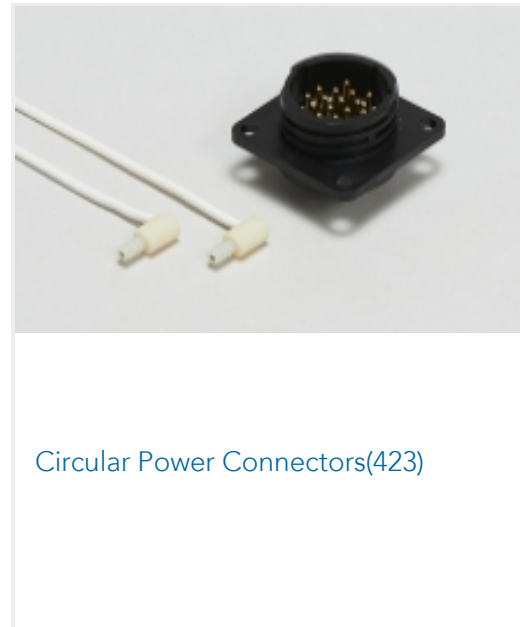
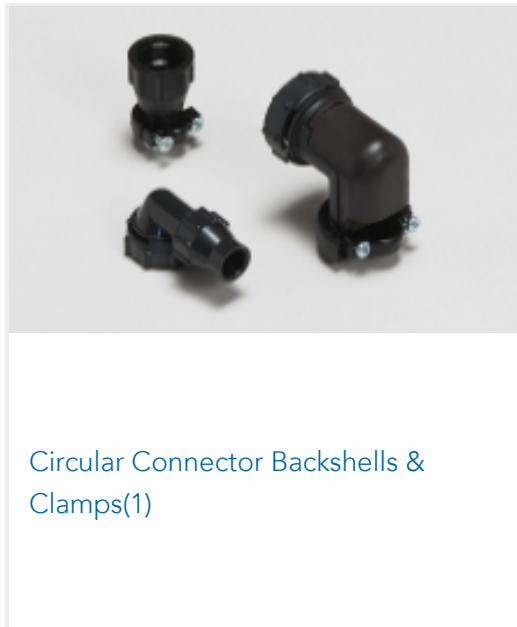

### Customers Also Bought

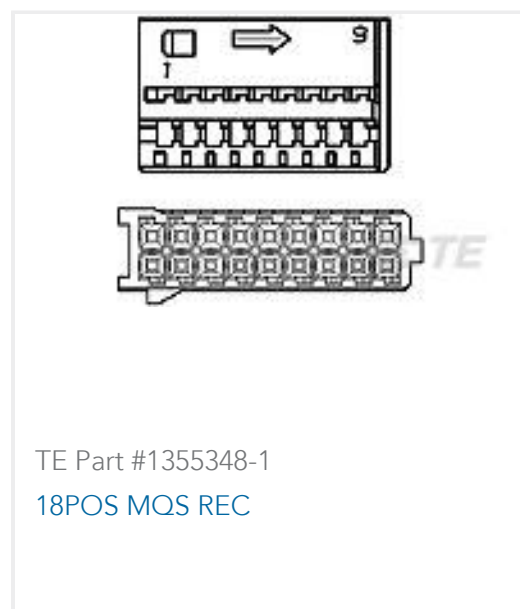
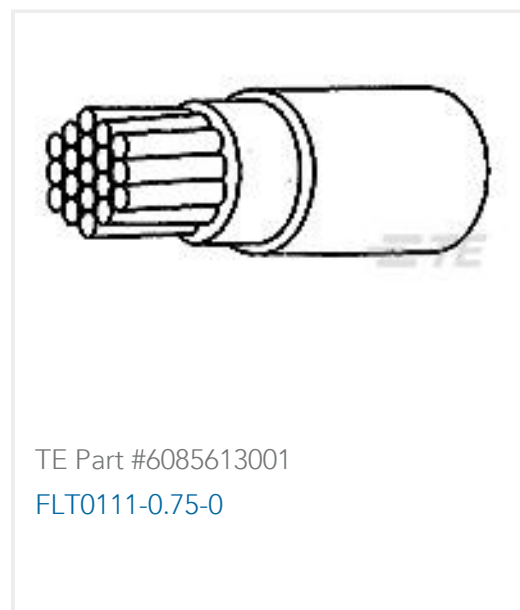



## Documents

### CAD Files

Customer View Model

[ENG\\_CVM\\_CVM\\_8-1437723-2\\_A.3d\\_stp.zip](#)

English

Customer View Model

[ENG\\_CVM\\_CVM\\_8-1437723-2\\_A.3d\\_igs.zip](#)

English

3D PDF

3D

Customer View Model

[ENG\\_CVM\\_CVM\\_8-1437723-2\\_A.2d\\_dxf.zip](#)

English

By downloading the CAD file I accept and agree to the [Terms and Conditions](#) of use.

### Datasheets & Catalog Pages

[1-1773902-9\\_CPC\\_Catalog](#)

English

[1-1773902-9\\_CPC\\_Catalog](#)

[1-1773902-9\\_CPC\\_Catalog](#)

German

[1-1773902-9\\_CPC\\_Catalog](#)

Japanese