



RAST

TE Internal #: 284930-4

TE Internal Description: DUOPLUG Standard, female conn.

[View on TE.com >](#)

Connectors > PCB Connectors > Card Edge Connectors > Standard Edge Connectors

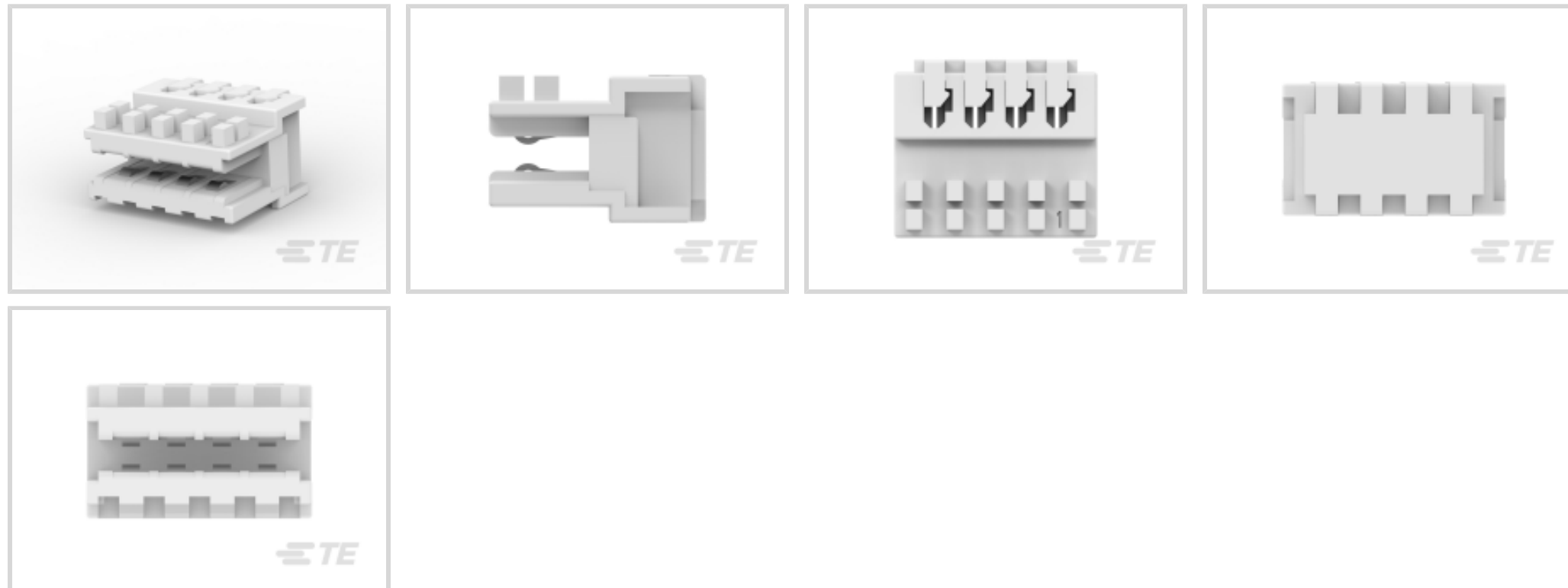

Connector System: **Wire-to-Board**

Number of Positions: **4**

Centerline (Pitch): **2.5 mm [.098 in]**

Termination Method to Wire & Cable: **Insulation Displacement (IDC)**

Number of Rows: **1**

Features

Product Type Features

Connector System	Wire-to-Board
Connector & Housing Type	Receptacle
Connector & Contact Terminates To	Printed Circuit Board

Configuration Features

Card Entry Style	Side
Number of Insulation Displacement Slots	4
Compatible With Wire & Cable Type	Discrete Wire
Number of Positions	4
Number of Rows	1
Connector Contact Load Condition	Fully Loaded
PCB Mount Orientation	Right Angle

Electrical Characteristics

Operating Voltage	63 VAC
-------------------	--------

Contact Features

PCB Contact Termination Area Plating Material Thickness	4 – 10 µm
---	-----------

Contact Mating Area Plating Material	Tin (Sn)
Contact Retention Within Housing	Without
Contact Base Material	Phosphor Bronze
PCB Contact Termination Area Plating Material	Tin
Contact Type	Socket
Contact Current Rating (Max)	2 A

Termination Features

Termination Method to Wire & Cable	Insulation Displacement (IDC)
------------------------------------	-------------------------------

Mechanical Attachment

Connector Mounting Type	Board Mount
-------------------------	-------------

Housing Features

Housing Entry Configuration	Both Ends Open
Centerline (Pitch)	2.5 mm[.098 in]
Housing Material	PBT GF

Dimensions

Card Slot Depth	5 mm
PCB Thickness (Recommended)	1.5 mm[.059 in]
Compatible Insulation Diameter Range	1.3 mm[.05 in]
Connector Height	7.35 mm
Wire Size	24 – 22 AWG

Operation/Application

Circuit Application	Signal
---------------------	--------

Packaging Features

Packaging Method	Tray
Packaging Quantity	364

Product Compliance

[For compliance documentation, visit the product page on TE.com>](#)

EU RoHS Directive 2011/65/EU	Compliant
EU ELV Directive 2000/53/EC	Compliant
China RoHS 2 Directive MIIT Order No 32, 2016	No Restricted Materials Above Threshold
EU REACH Regulation (EC) No. 1907/2006	



Current ECHA Candidate List: JAN 2025
(247)

Candidate List Declared Against: JAN 2024
(240)

Does not contain REACH SVHC

Halogen Content

Not Low Halogen - contains Br or Cl > 900 ppm.

Solder Process Capability

Not applicable for solder process capability

Product Compliance Disclaimer

This information is provided based on reasonable inquiry of our suppliers and represents our current actual knowledge based on the information they provided. This information is subject to change. The part numbers that TE has identified as EU RoHS compliant have a maximum concentration of 0.1% by weight in homogenous materials for lead, hexavalent chromium, mercury, PBB, PBDE, DBP, BBP, DEHP, DIBP, and 0.01% for cadmium, or qualify for an exemption to these limits as defined in the Annexes of Directive 2011/65/EU (RoHS2). Finished electrical and electronic equipment products will be CE marked as required by Directive 2011/65/EU. Components may not be CE marked. Additionally, the part numbers that TE has identified as EU ELV compliant have a maximum concentration of 0.1% by weight in homogenous materials for lead, hexavalent chromium, and mercury, and 0.01% for cadmium, or qualify for an exemption to these limits as defined in the Annexes of Directive 2000/53/EC (ELV). Regarding the REACH Regulation, the information TE provides on SVHC in articles for this part number is based on the latest European Chemicals Agency (ECHA) 'Guidance on requirements for substances in articles' posted at this URL: <https://echa.europa.eu/guidance-documents/guidance-on-reach>

Compatible Parts

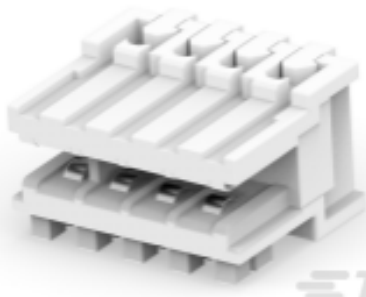

TE Part # 284932-4
DUOPLUG MKI STD,KEYED 1/2,4 POS, ORANGE



TE Part # 2-284932-8
DUOPLUG MKI STD,KEYED 2/3,8 POS, ORANGE



TE Part # 284930-6
DUOPLUG Standard, female conn.



TE Part # 2402726-4
Same as 284930-4 w/ alternative resin



TE Part # 284930-3
DUOPLUG Standard, female conn.



TE Part # 284930-5
DUOPLUG Standard, female conn.



TE Part # 284930-8
DUOPLUG Standard, female conn.

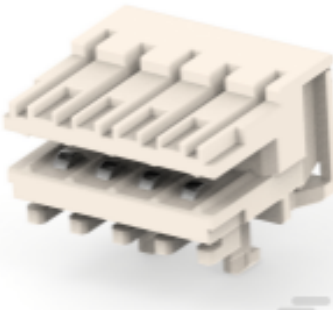

TE Part # 2-2304525-4
AMP DUOPLUG MK2 CONNECTOR 4P

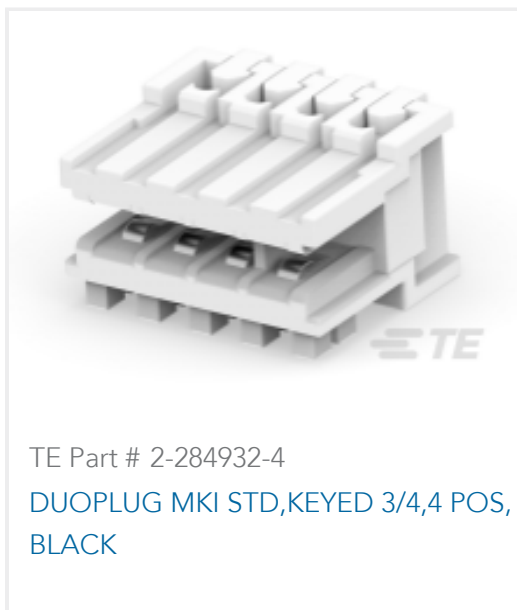

TE Part # 2-284932-4
DUOPLUG MKI STD, KEYED 3/4, 4 POS,
BLACK



TE Part # 9-964575-4
DUOPLUG2, 5 RAHMEN 4P



TE Part # 1-284932-0
DUOPLUG STD 10 POS POL FULLY
LOADED

Customers Also Bought

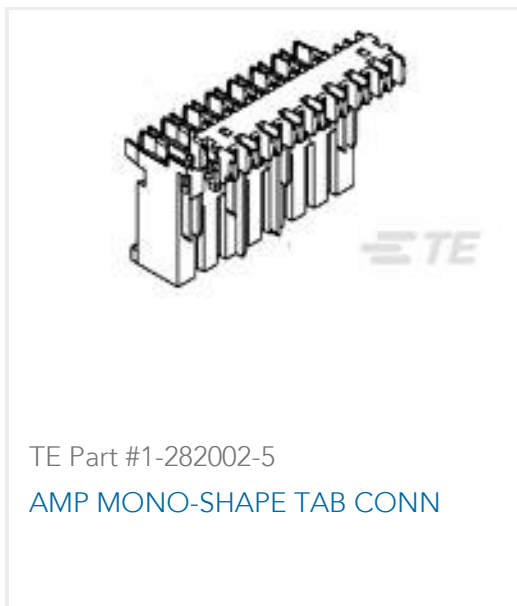

TE Part # 1-282002-5
AMP MONO-SHAPE TAB CONN

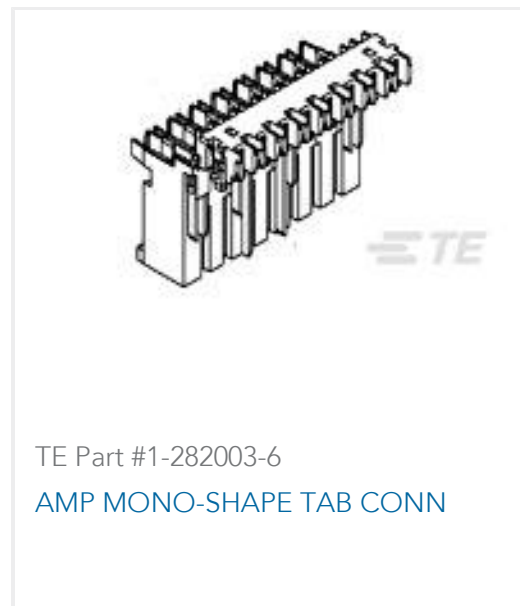

TE Part # 1-282003-6
AMP MONO-SHAPE TAB CONN

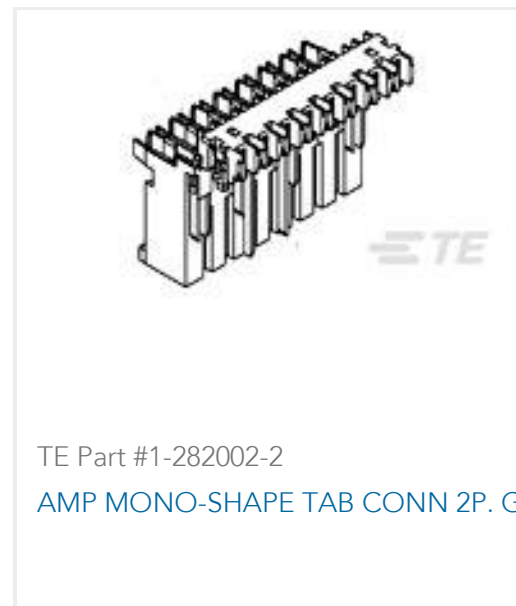

TE Part # 1-282002-2
AMP MONO-SHAPE TAB CONN 2P. G



TE Part # 280001-9
250 FASTON, REC., 14-17 AWG, TPBR

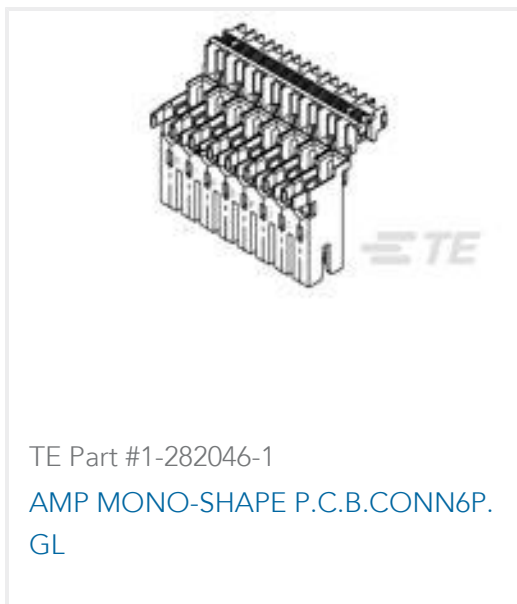

TE Part # 1-282046-1
AMP MONO-SHAPE P.C.B. CONN 6P.
GL

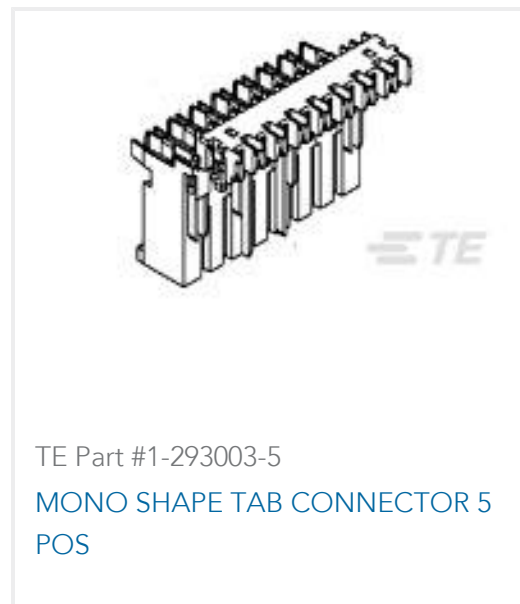

TE Part # 1-293003-5
MONO SHAPE TAB CONNECTOR 5
POS

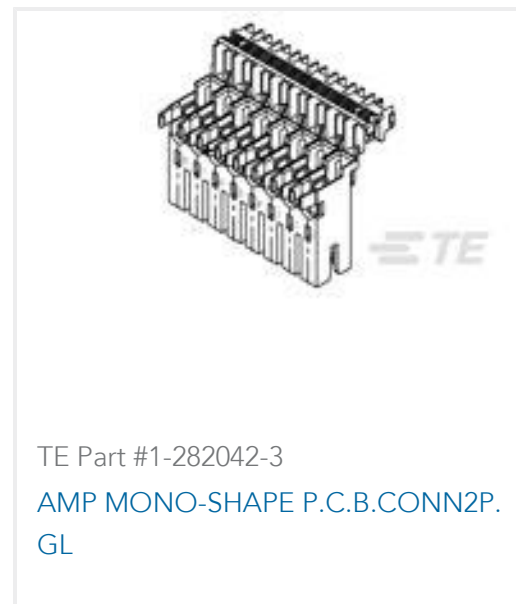

TE Part # 1-282042-3
AMP MONO-SHAPE P.C.B. CONN 2P.
GL



TE Part # 175022-1
250 PL EX REC. 18-14AWG PTBR



TE Part # 293207-3
DUOPLUG Std conn., 3 pos, gwt750 v0

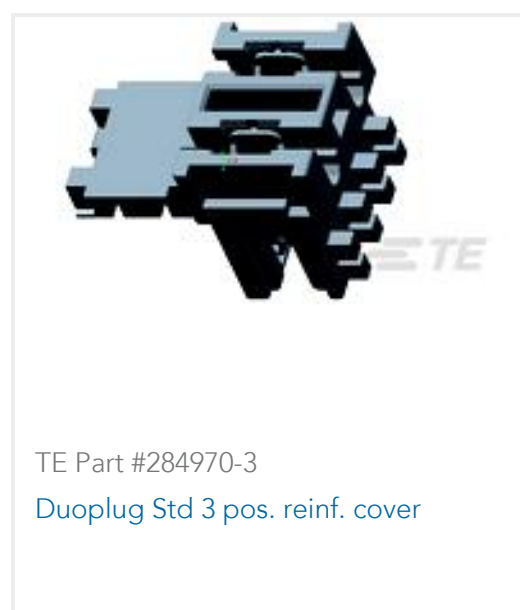

TE Part # 284970-3
Duoplug Std 3 pos. reinf. cover

Documents

Product Drawings

DUOPLUG Standard, female conn.

English

CAD Files

3D PDF

3D

Customer View Model

ENG_CVM_CVM_284930-4_B.2d_dxf.zip



English

Customer View Model

[ENG_CVM_CVM_284930-4_B.3d_igs.zip](#)

English

Customer View Model

[ENG_CVM_CVM_284930-4_B.3d_stp.zip](#)

English

By downloading the CAD file I accept and agree to the [Terms and Conditions](#) of use.

Datasheets & Catalog Pages

[RAST Connector System Catalog](#)

English

Product Specifications

[Application Specification](#)

English

Agency Approvals

[Agency Approval Document](#)

English