



Economy Power 2.5

TE Internal #: 2-1969541-2

TPA (Terminal Position Assurance), Black, 22 Position, Economy Power 2.5

[View on TE.com >](#)

Connectors > Connector Accessories > Connector Hardware

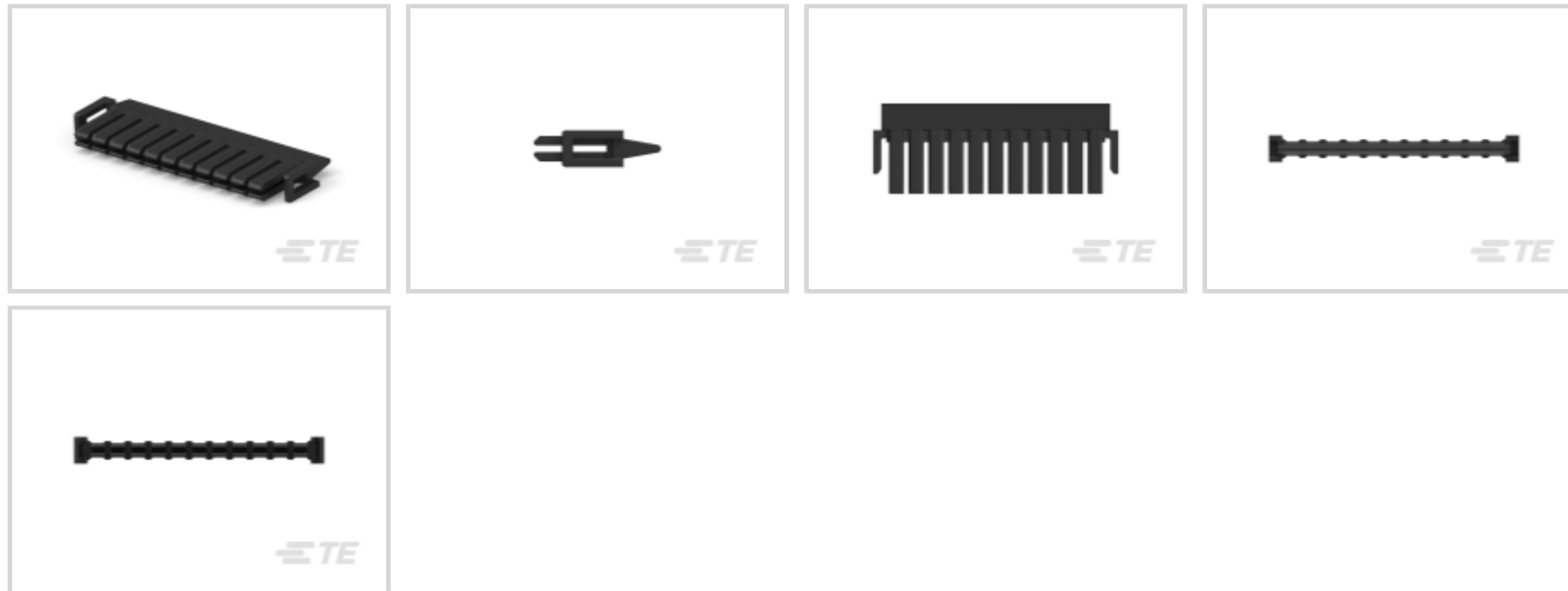

Connector Hardware Accessory Type: **TPA (Terminal Position Assurance)**

Primary Product Color: **Black**

Number of Positions: **22**

Operating Temperature (Max): **105 °C [221 °F]**

Operating Temperature Range: **-55 – 105 °C [-67 – 221 °F]**

Features

Product Type Features

Connector Hardware Accessory Type	TPA (Terminal Position Assurance)
Hardware Accessory Function	Position Assurance

Configuration Features

Number of Rows	2
Number of Positions	22

Body Features

Primary Product Color	Black
-----------------------	-------

Housing Features

Centerline (Pitch)	2.5 mm [.098 in]
--------------------	------------------

Dimensions

Product Height	11.35 mm [.45 in]
----------------	-------------------

Usage Conditions

Operating Temperature (Max)	105 °C [221 °F]
Operating Temperature Range	-55 – 105 °C [-67 – 221 °F]



Industry Standards

Glow Wire Rating	Standard Part - Not Glow Wire
------------------	-------------------------------

Packaging Features

Packaging Method	Bag
Packaging Quantity	4300

Product Compliance

[For compliance documentation, visit the product page on TE.com>](#)

EU RoHS Directive 2011/65/EU	Compliant
EU ELV Directive 2000/53/EC	Compliant
China RoHS 2 Directive MIIT Order No 32, 2016	No Restricted Materials Above Threshold
EU REACH Regulation (EC) No. 1907/2006	Current ECHA Candidate List: JAN 2025 (247) Candidate List Declared Against: JAN 2025 (247) Does not contain REACH SVHC
Halogen Content	Low Halogen - Br, Cl, F, I < 900 ppm per homogenous material. Also BFR/CFR/PVC Free
Solder Process Capability	Not applicable for solder process capability

Product Compliance Disclaimer

This information is provided based on reasonable inquiry of our suppliers and represents our current actual knowledge based on the information they provided. This information is subject to change. The part numbers that TE has identified as EU RoHS compliant have a maximum concentration of 0.1% by weight in homogenous materials for lead, hexavalent chromium, mercury, PBB, PBDE, DBP, BBP, DEHP, DIBP, and 0.01% for cadmium, or qualify for an exemption to these limits as defined in the Annexes of Directive 2011/65/EU (RoHS2). Finished electrical and electronic equipment products will be CE marked as required by Directive 2011/65/EU. Components may not be CE marked. Additionally, the part numbers that TE has identified as EU ELV compliant have a maximum concentration of 0.1% by weight in homogenous materials for lead, hexavalent chromium, and mercury, and 0.01% for cadmium, or qualify for an exemption to these limits as defined in the Annexes of Directive 2000/53/EC (ELV). Regarding the REACH Regulation, the information TE provides on SVHC in articles for this part number is based on the latest European Chemicals Agency (ECHA) 'Guidance on requirements for substances in articles' posted at this URL: <https://echa.europa.eu/guidance-documents/guidance-on-reach>

Compatible Parts

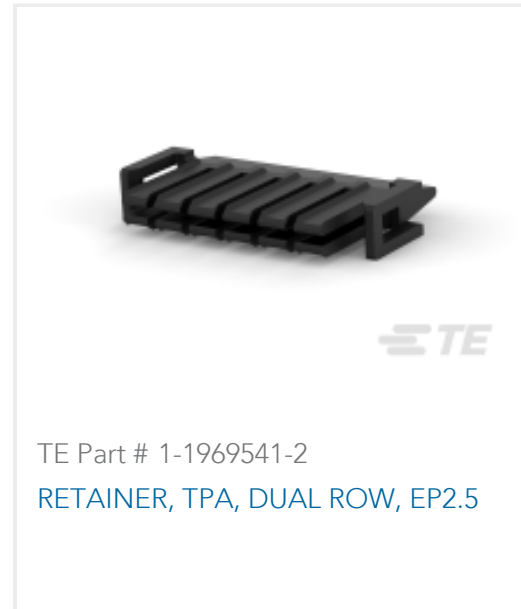

Also in the Series | Economy Power 2.5

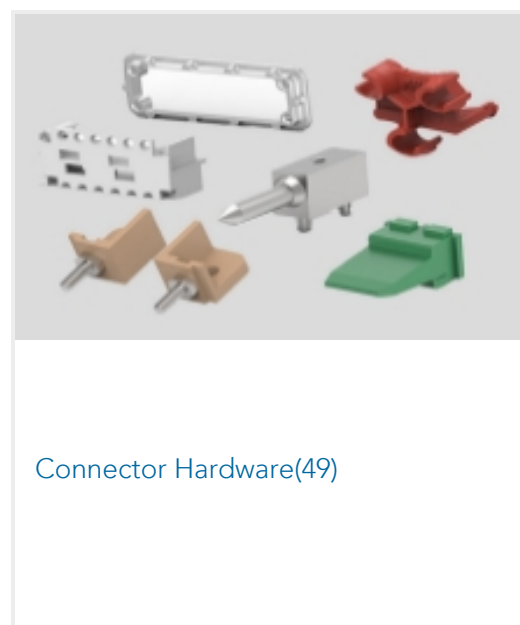
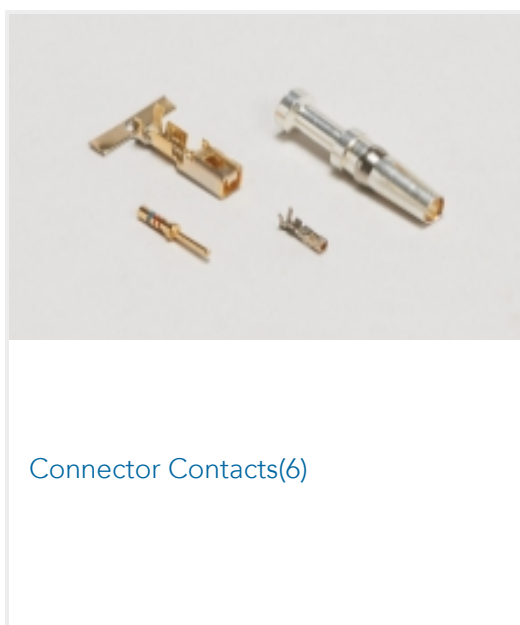

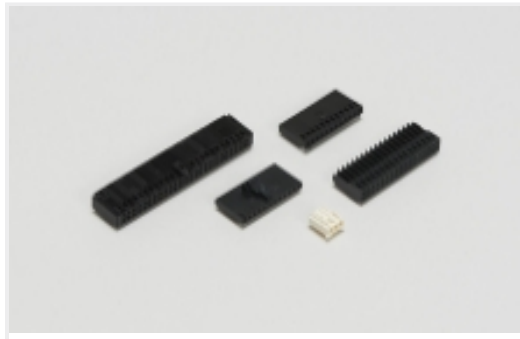

Wire-to-Board Connector Assemblies & Housings(305)

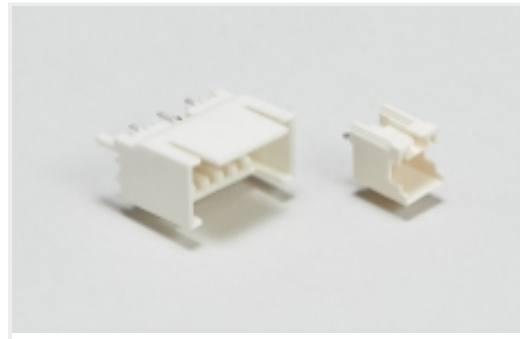

Wire-to-Board Headers & Receptacles (533)

Customers Also Bought



TE Part #CAT-D48-ST273
DEUTSCH Solid Contacts



TE Part #CAT-D487-W416
Wedgelocks: DEUTSCH DT



TE Part #DT06-2S
PLG, 2P, GRY, N



TE Part #DT04-2P
REC, 2P, GRY, N



TE Part #114017-ZZ
SEALING PLUG, SIZE 12/16, WHT



TE Part #CAT-AM71-CH8172
AMP SUPERSEAL 1.5MM,
CONNECTOR HOUSING

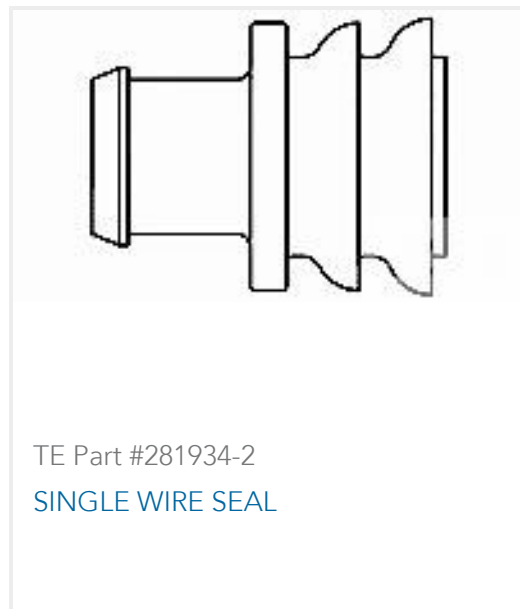

TE Part #281934-2
SINGLE WIRE SEAL

Documents

Product Drawings

[RETAINER, TPA, DUAL ROW, EP2.5](#)

English

CAD Files

[3D PDF](#)

3D

Customer View Model

[ENG_CVM_CVM_2-1969541-2_A.2d_dxf.zip](#)

English

Customer View Model

[ENG_CVM_CVM_2-1969541-2_A.3d_igs.zip](#)

English

Customer View Model

[ENG_CVM_CVM_2-1969541-2_A.3d_stp.zip](#)

English

By downloading the CAD file I accept and agree to the [Terms and Conditions](#) of use.



Datasheets & Catalog Pages

[7-1773461-6_EP2.5_Connector_Series](#)

English

Product Specifications

[Application Specification](#)

English

Instruction Sheets

[Instruction Sheet \(U.S.\)](#)

English