

1452416-1 ✓ ACTIVE

AMP | MCON 1.2mm, MCON Interconnection System

TE Internal #: 1452416-1

Black, Cover Assembly, PBT GF20, 180° Cable Exit, -40 – 125 °C
[-40 – 257 °F], MCON Interconnection System

[View on TE.com >](#)



Connectors > Automotive Connectors > Automotive Connector Accessories > Automotive Connector Caps & Covers



Primary Product Color: **Black**

Protection & Strain Relief Accessory Type: **Cover Assembly**

Primary Product Material: **PBT GF20**

Cable Exit Angle: **180°**

Strain Relief: **Without**

Features

Product Type Features

Sealable	No
Protection & Strain Relief Accessory Type	Cover Assembly

Body Features

Primary Product Color	Black
Primary Product Material	PBT GF20
Cable Exit Angle	180°

Mechanical Attachment

Strain Relief	Without
---------------	---------

Usage Conditions

Operating Temperature (Max)	125 °C[257 °F]
Operating Temperature Range	-40 – 125 °C[-40 – 257 °F]

Packaging Features

Packaging Method	Box
Packaging Quantity	320

Product Compliance

[For compliance documentation, visit the product page on TE.com>](#)

EU RoHS Directive 2011/65/EU	Compliant
------------------------------	-----------



EU ELV Directive 2000/53/EC	Compliant
China RoHS 2 Directive MIIT Order No 32, 2016	No Restricted Materials Above Threshold
EU REACH Regulation (EC) No. 1907/2006	Current ECHA Candidate List: JAN 2025 (247) Candidate List Declared Against: JAN 2025 (247) Does not contain REACH SVHC
Halogen Content	BFR/CFR/PVC Free, but Br/Cl >900 ppm in other sources.
Solder Process Capability	Not applicable for solder process capability

Product Compliance Disclaimer

This information is provided based on reasonable inquiry of our suppliers and represents our current actual knowledge based on the information they provided. This information is subject to change. The part numbers that TE has identified as EU RoHS compliant have a maximum concentration of 0.1% by weight in homogenous materials for lead, hexavalent chromium, mercury, PBB, PBDE, DBP, BBP, DEHP, DIBP, and 0.01% for cadmium, or qualify for an exemption to these limits as defined in the Annexes of Directive 2011/65/EU (RoHS2). Finished electrical and electronic equipment products will be CE marked as required by Directive 2011/65/EU. Components may not be CE marked. Additionally, the part numbers that TE has identified as EU ELV compliant have a maximum concentration of 0.1% by weight in homogenous materials for lead, hexavalent chromium, and mercury, and 0.01% for cadmium, or qualify for an exemption to these limits as defined in the Annexes of Directive 2000/53/EC (ELV). Regarding the REACH Regulation, the information TE provides on SVHC in articles for this part number is based on the latest European Chemicals Agency (ECHA) 'Guidance on requirements for substances in articles' posted at this URL: <https://echa.europa.eu/guidance-documents/guidance-on-reach>

Compatible Parts

 TE Part # 4-1564285-4 58POS, MIXED,REC HSG,ASSY	 TE Part # 7-1564285-5 58POS, MIXED,REC HSG,ASSY	 TE Part # 7-1564285-6 58POS, MIXED,REC HSG,ASSY	 TE Part # 5-1564285-0 58POS, MIXED,REC HSG,ASSY
 TE Part # 9-1452415-2 58 POS MIXED, MCON CONNECTOR	 TE Part # 3-1564285-2 58POS, MIXED,REC HSG,ASSY	 TE Part # 4-1563172-4 58POS, MIXED,REC HSG,ASSY	 TE Part # 5-1563172-4 58POS, MIXED,REC HSG,ASSY



Also in the Series | **MCON 1.2mm**

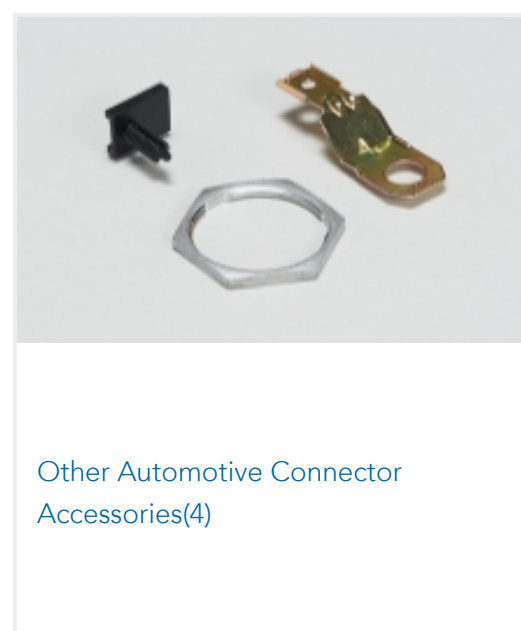
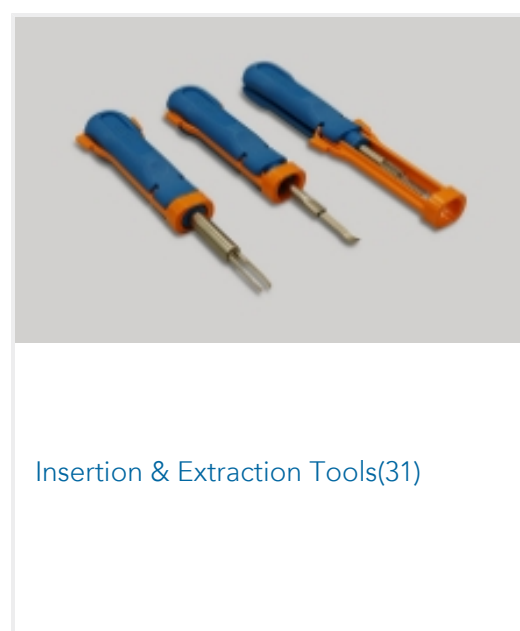
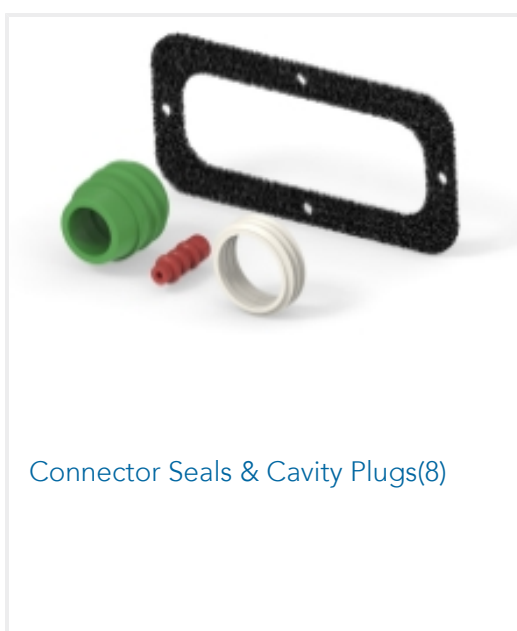
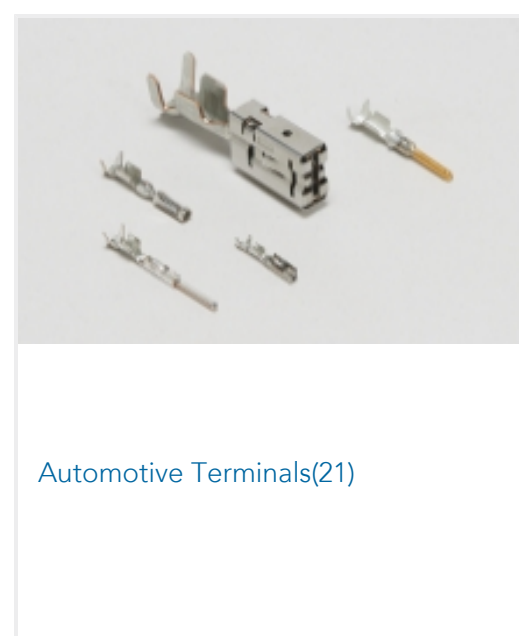
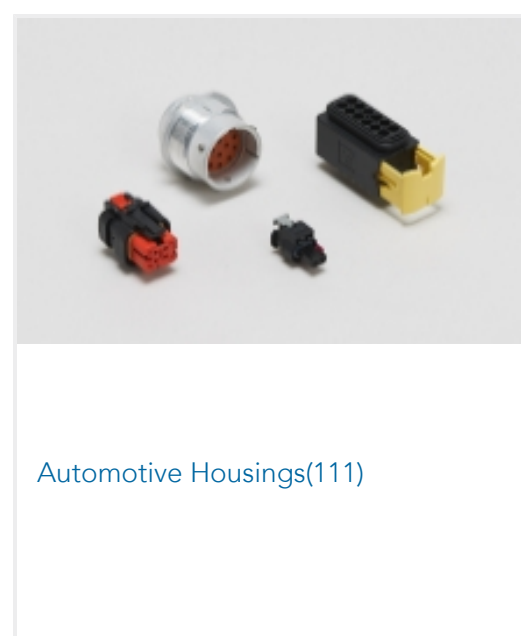

Also in the Series | **MCON Interconnection System**

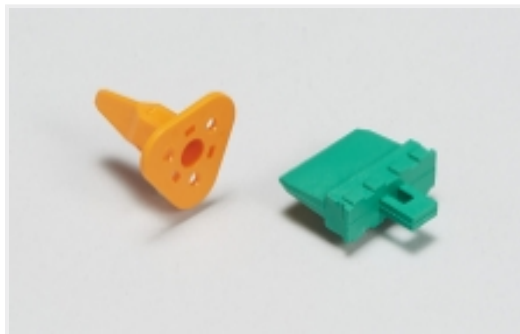

Automotive Connector Locks & Position Assurance(15)



Automotive Headers(3)



Automotive Housings(111)



Connector Seals & Cavity Plugs(8)



Insertion & Extraction Tools(31)



Other Automotive Connector Accessories(4)

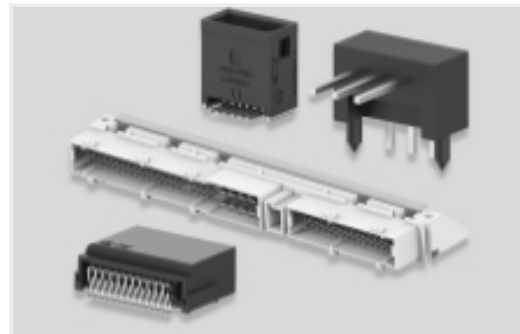

PCB Headers & Receptacles(3)



Rectangular Power Connectors(1)

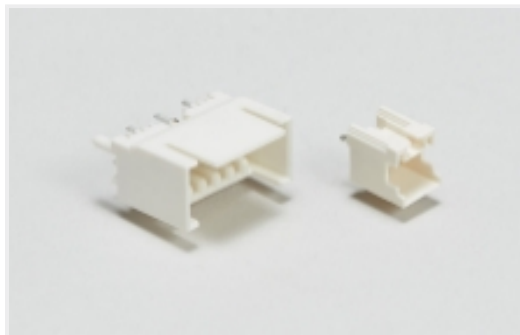

Wire-to-Board Headers & Receptacles (1)

Customers Also Bought

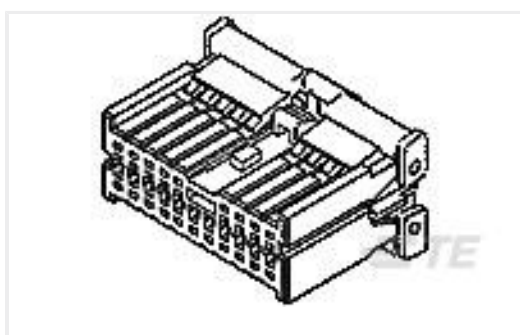

TE Part #1123371-1
040-3 MLC PLUG HSG ASSY 16P



TE Part #1452388-2
SECONDARY LOCK FOR 96 POS CONN



TE Part #1326032-9
2.8MM RECP,SEAL,18AWG,REV REEL



TE Part #2822636-1
EJ-2 DBL LOCK PLUG 4P ASSY A



TE Part #9-1452415-9
58POS CONNECTOR ASSY F. CONNECTOR154POS



TE Part #9-1452423-9
96 POS. CONNECTOR ASSY



TE Part #K1060570
Relay 29-114-12



TE Part #1801175-6
2W RECEPTACLE HP CONNECTOR BROWN



Documents

Product Drawings

[58POS CONNECTOR COVER 180 ASSY](#)

English

CAD Files

[3D PDF](#)

3D

Customer View Model

[ENG_CVM_CVM_1452416-1_D.2d_dxf.zip](#)

English

Customer View Model

[ENG_CVM_CVM_1452416-1_D.3d_igs.zip](#)

English

Customer View Model

[ENG_CVM_CVM_1452416-1_D.3d_stp.zip](#)

English

By downloading the CAD file I accept and agree to the [Terms and Conditions](#) of use.

Product Specifications

[Application Specification](#)

English