

103906-3 ✓ ACTIVE

AMPMODU | AMPMODU MTE

TE Internal #: 103906-3

PCB Mount Header, Right Angle, Wire-to-Board, 4 Position, 2.54 mm [.1 in] Centerline, Fully Shrouded, Gold (Au), Through Hole - Solder, AMPMODU MTE

[View on TE.com >](#)



Connectors > PCB Connectors > PCB Headers & Receptacles

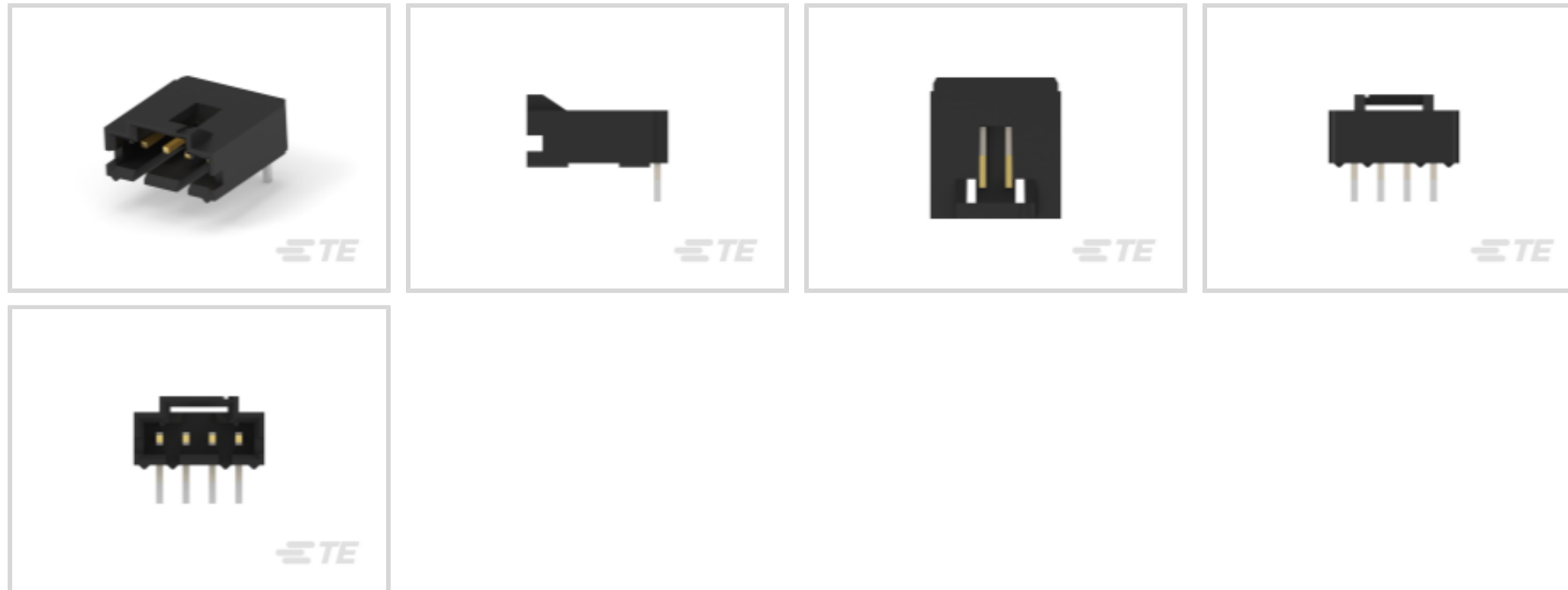

PCB Connector Type: **PCB Mount Header**

PCB Mount Orientation: **Right Angle**

Connector System: **Wire-to-Board**

Number of Positions: **4**

Number of Rows: **1**

## Features

### Product Type Features

PCB Connector Type	PCB Mount Header
Connector System	Wire-to-Board
Header Type	Fully Shrouded
Sealable	No
Connector & Contact Terminates To	Printed Circuit Board
Connector Product Type	Connector Assembly

### Configuration Features

PCB Mount Orientation	Right Angle
Number of Positions	4
Number of Rows	1

### Electrical Characteristics

Termination Resistance	15 mΩ
Insulation Resistance	5000 MΩ
Dielectric Withstanding Voltage (Max)	600 V



### Body Features

Primary Product Color	Black
-----------------------	-------

### Contact Features

PCB Contact Termination Area Plating Material Finish	Matte
Contact Mating Area Plating Material Thickness	.381 $\mu\text{m}$ [30 $\mu\text{in}$ ]
Mating Square Post Dimension	.64 mm[.025 in]
PCB Contact Termination Area Plating Material Thickness	2.54 – 5.08 $\mu\text{m}$ [100 – 200 $\mu\text{in}$ ]
Contact Shape & Form	Square
Contact Mating Area Length	5.84 mm[.23 in]
Contact Base Material	Brass
PCB Contact Termination Area Plating Material	Tin-Lead
Contact Mating Area Plating Material	Gold (Au)
Contact Type	Pin
Contact Current Rating (Max)	3 A

### Termination Features

Termination Post & Tail Length	3.3 mm[.13 in]
Square Termination Post & Tail Dimension	.64 mm[.025 in]
Termination Method to PCB	Through Hole - Solder

### Mechanical Attachment

Mating Retention Type	Polarized Lock
Mating Retention	With
Mating Alignment Type	Latched, Polarization
PCB Mount Retention	Without
PCB Mount Alignment	Without
Connector Mounting Type	Board Mount
Mating Alignment	With

### Housing Features

Housing Material	Thermoplastic
Centerline (Pitch)	2.54 mm[.1 in]

### Dimensions

Connector Height	6.99 mm[.275 in]
Connector Length	12.7 mm[.5 in]



### Usage Conditions

Operating Temperature Range	-65 – 105 °C[-85 – 221 °F]
-----------------------------	----------------------------

### Operation/Application

Circuit Application	Signal
---------------------	--------

### Industry Standards

Compatible With Approved Standards Products	CSA LR7189, UL E28476
UL Flammability Rating	UL 94V-0

### Packaging Features

Packaging Quantity	42
Packaging Method	Box, Tube

### Product Compliance

[For compliance documentation, visit the product page on TE.com>](#)

EU RoHS Directive 2011/65/EU	Not Compliant
EU ELV Directive 2000/53/EC	Compliant with Exemptions
China RoHS 2 Directive MIIT Order No 32, 2016	Restricted Materials Above Threshold
EU REACH Regulation (EC) No. 1907/2006	Current ECHA Candidate List: JAN 2025 (247) Candidate List Declared Against: JAN 2025 (247) SVHC > Threshold: Pb (13% in 4690971273) <b>Article Safe Usage Statements:</b> Do not eat, drink or smoke when using this product. Wash thoroughly after handling. Recycle if possible and dispose of the article by following all applicable governmental regulations relevant to your geographic location.
Halogen Content	Low Halogen - Br, Cl, F, I < 900 ppm per homogenous material. Also BFR/CFR/PVC Free
Solder Process Capability	Reflow solder capable to 260°C

#### Product Compliance Disclaimer

This information is provided based on reasonable inquiry of our suppliers and represents our current actual knowledge based on the information they provided. This information is subject to change. The part numbers that TE has identified as EU RoHS compliant have a maximum concentration of 0.1% by weight in homogenous materials for lead, hexavalent chromium, mercury, PBB, PBDE, DBP, BBP, DEHP, DIBP, and 0.01% for cadmium, or qualify for an exemption to these limits as defined in the Annexes of Directive 2011/65/EU (RoHS2). Finished electrical and electronic equipment products will be CE marked as required by Directive 2011/65/EU. Components may not be CE marked. Additionally, the part numbers that TE has identified as EU ELV compliant have a maximum concentration of 0.1% by weight in homogenous materials for lead, hexavalent chromium, and mercury, and 0.01% for cadmium, or qualify for an exemption to these limits as defined in the Annexes of Directive 2000/53/EC (ELV). Regarding the REACH Regulation, the information TE provides on SVHC in articles for this part number is based on the latest European Chemicals Agency (ECHA) 'Guidance on requirements for substances in articles' posted at this URL: <https://echa.europa.eu/guidance-documents/guidance-on-reach>

## Compatible Parts



TE Part # 103958-3  
5X4 MTE RCPT SR LATCH .100CL



TE Part # 487526-3  
004 HOUSING FFC RCPT 100CL SR



TE Part # 103961-3  
5X4 MTE RCPT SR LATHC .100CL

## Also in the Series | AMPMODU MTE

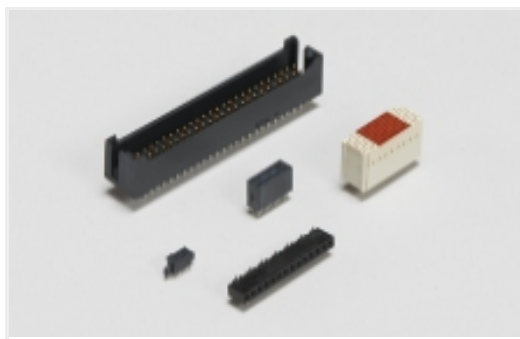

Board-to-Board Headers & Receptacles(24)



Connector Caps & Covers(18)



Connector Contacts(27)

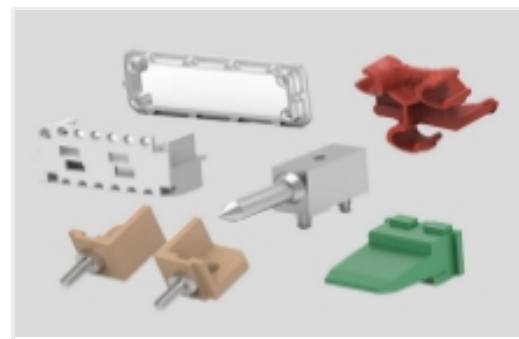

Connector Hardware(1)

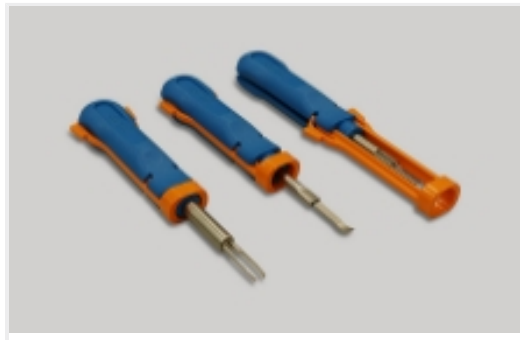

Insertion & Extraction Tools(1)

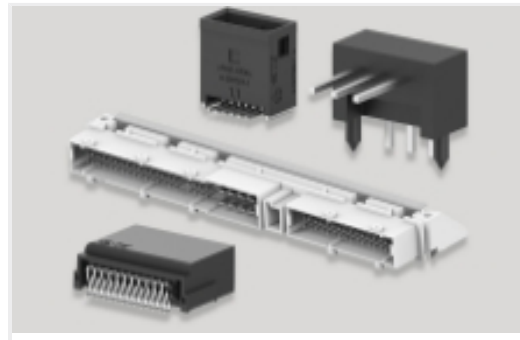

PCB Headers & Receptacles(444)

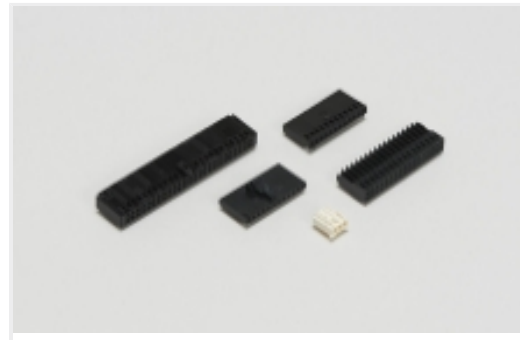

Wire-to-Board Connector Assemblies & Housings(298)

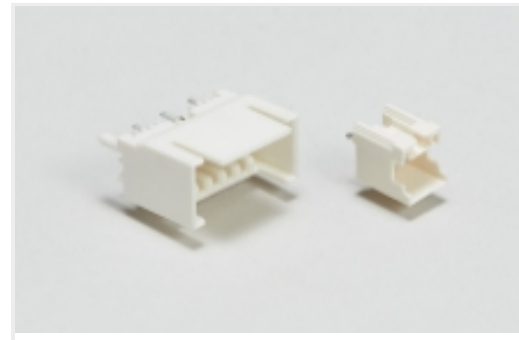

Wire-to-Board Headers & Receptacles (420)

## Customers Also Bought



TE Part #1825027-5  
FSMRA2JH04=R/A,TACT PB SW,160G

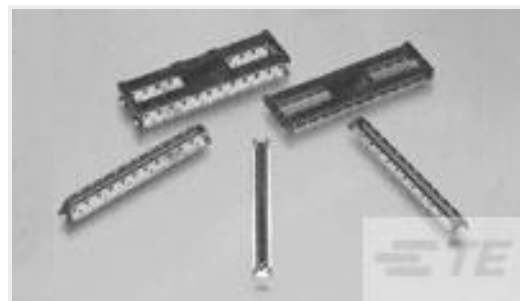

TE Part #3-5353652-6  
.5FHP08H,440,B,GIG,08/Sn,HT,NSYes

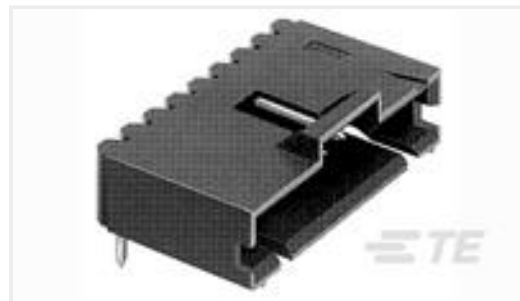

TE Part #5-104935-2  
08 MTE HDR SRR LATCH



TE Part #86434-1  
MOD I RECP LP

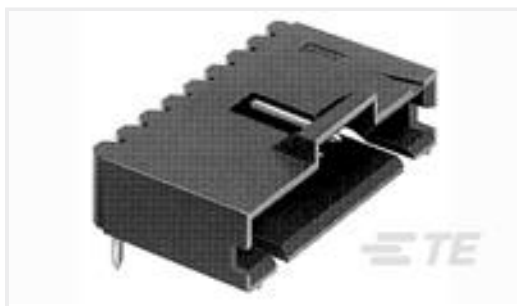

TE Part #103906-1  
02 MTE HDR SRRA LATCH .100CL

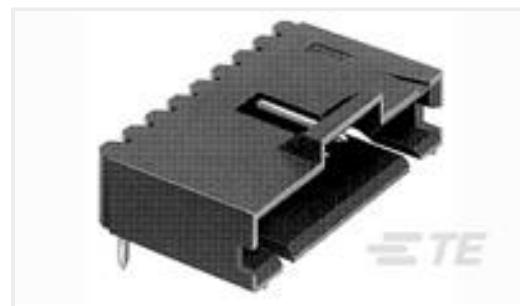

TE Part #103906-7  
08 MTE HDR SRRA LATCH .100CL



TE Part #1888247-1  
20 POS SMT CONN, SFP/SFP+, 30A



TE Part #100147-1  
Z-PACK/A F-HDR.110P



TE Part #1571983-1  
GDH02S04=DIP SWITCH



TE Part #6-103672-5  
16 MTE HDR SRRA LATCH W/HLDWN

## Documents

### Product Drawings

[04 MTE HDR SRRA LATCH .100CL](#)

English

### CAD Files

[3D PDF](#)

3D

Customer View Model

[ENG\\_CVM\\_CVM\\_103906-3\\_S.2d\\_dxf.zip](#)

English

Customer View Model

[ENG\\_CVM\\_CVM\\_103906-3\\_S.3d\\_igs.zip](#)

English

Customer View Model

[ENG\\_CVM\\_CVM\\_103906-3\\_S.3d\\_stp.zip](#)

English

By downloading the CAD file I accept and agree to the [Terms and Conditions](#) of use.

### Datasheets & Catalog Pages

[AMPMODU MTE INTERCONNECT SYSTEM](#)

English

### Product Specifications

[Application Specification](#)

English

### Instruction Sheets

[Instruction Sheet \(U.S.\)](#)

103906-3

PCB Mount Header, Right Angle, Wire-to-Board, 4 Position, 2.54 mm [.1 in]  
Centerline, Fully Shrouded, Gold (Au), Through Hole - Solder, AMPMODU MTE



English