



Connectors > Connector Accessories > Connector Caps & Covers > Nylon PCB Connector Covers: 2.54mm, MTA 100



Connector Cover Type: **Strain Relief Cover**

Primary Product Color: **White**

Primary Product Material: **Nylon**

Number of Positions: **18**

Operating Temperature (Max): **85 °C [185 °F]**

[All Nylon PCB Connector Covers: 2.54mm, MTA 100 \(40\)](#)

Features

Product Type Features

| | |
|----------------------|---------------------|
| Product Profile | Standard |
| Connector Cover Type | Strain Relief Cover |

Configuration Features

| | |
|---------------------|----|
| Number of Positions | 18 |
|---------------------|----|

Body Features

| | |
|--------------------------|-------|
| Primary Product Color | White |
| Primary Product Material | Nylon |

Mechanical Attachment

| | |
|---------------|------|
| Strain Relief | With |
|---------------|------|

Housing Features

| | |
|--------------------|-----------------|
| Centerline (Pitch) | 2.54 mm [.1 in] |
|--------------------|-----------------|

Usage Conditions

| | |
|-------------------------------------------------|------------|
| Compatible With IDC Installation Type Connector | Closed End |
|-------------------------------------------------|------------|

| | |
|-----------------------------|---------------------------|
| Operating Temperature (Max) | 85 °C[185 °F] |
| Operating Temperature Range | -40 – 85 °C[-40 – 185 °F] |

Industry Standards

| | |
|------------------------|----------|
| UL Flammability Rating | UL 94V-2 |
|------------------------|----------|

Product Compliance

[For compliance documentation, visit the product page on TE.com>](#)

| | |
|-----------------------------------------------|--------------------------------------------------------------------------------------------------------------------------------|
| EU RoHS Directive 2011/65/EU | Compliant |
| EU ELV Directive 2000/53/EC | Compliant |
| China RoHS 2 Directive MIIT Order No 32, 2016 | No Restricted Materials Above Threshold |
| EU REACH Regulation (EC) No. 1907/2006 | Current ECHA Candidate List: JAN 2025 (247) Candidate List Declared Against: JUNE 2024 (241) Does not contain REACH SVHC |
| Halogen Content | Low Halogen - Br, Cl, F, I < 900 ppm per homogenous material. Also BFR/CFR/PVC Free |
| Solder Process Capability | Not applicable for solder process capability |

Product Compliance Disclaimer

This information is provided based on reasonable inquiry of our suppliers and represents our current actual knowledge based on the information they provided. This information is subject to change. The part numbers that TE has identified as EU RoHS compliant have a maximum concentration of 0.1% by weight in homogenous materials for lead, hexavalent chromium, mercury, PBB, PBDE, DBP, BBP, DEHP, DIBP, and 0.01% for cadmium, or qualify for an exemption to these limits as defined in the Annexes of Directive 2011/65/EU (RoHS2). Finished electrical and electronic equipment products will be CE marked as required by Directive 2011/65/EU. Components may not be CE marked. Additionally, the part numbers that TE has identified as EU ELV compliant have a maximum concentration of 0.1% by weight in homogenous materials for lead, hexavalent chromium, and mercury, and 0.01% for cadmium, or qualify for an exemption to these limits as defined in the Annexes of Directive 2000/53/EC (ELV). Regarding the REACH Regulation, the information TE provides on SVHC in articles for this part number is based on the latest European Chemicals Agency (ECHA) 'Guidance on requirements for substances in articles' posted at this URL: <https://echa.europa.eu/guidance-documents/guidance-on-reach>

Compatible Parts





Also in the Series | **MTA 100**

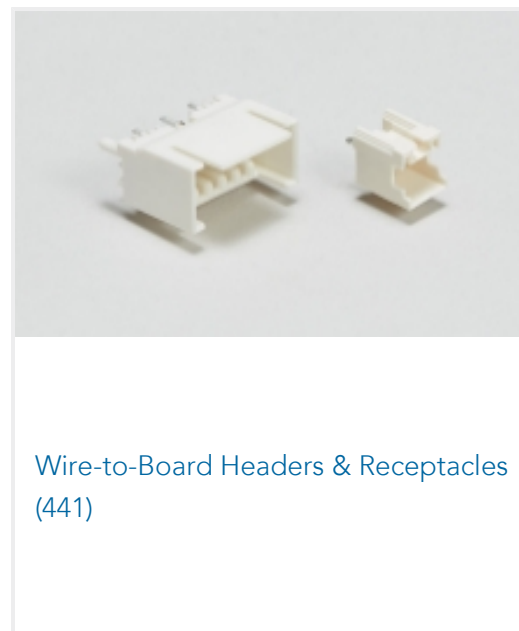
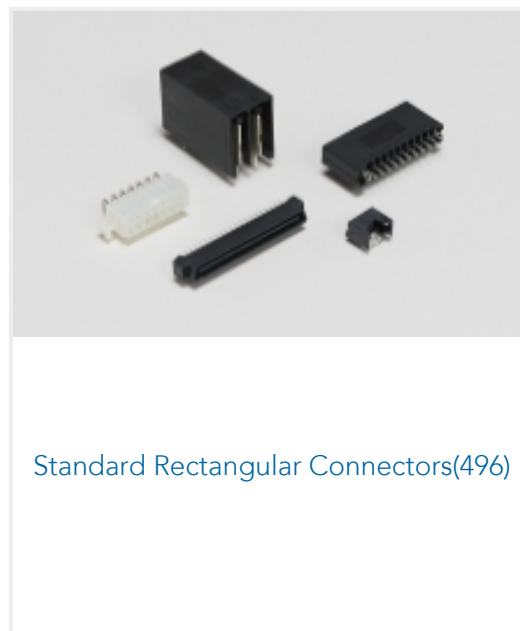
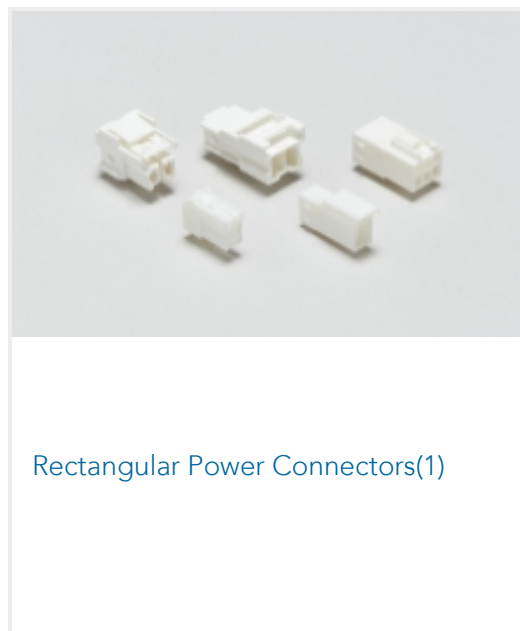
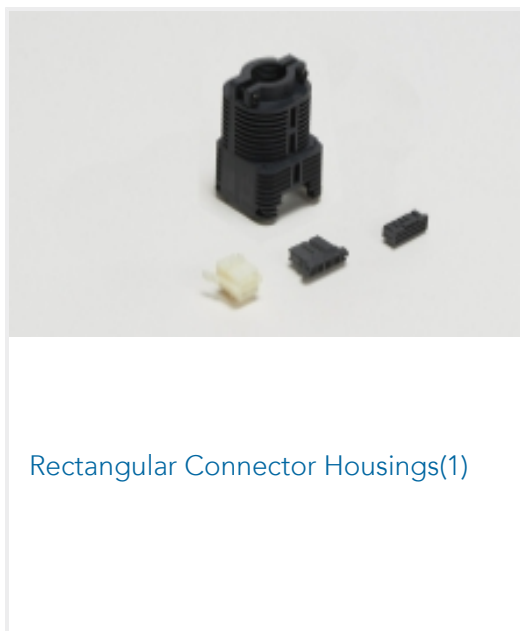
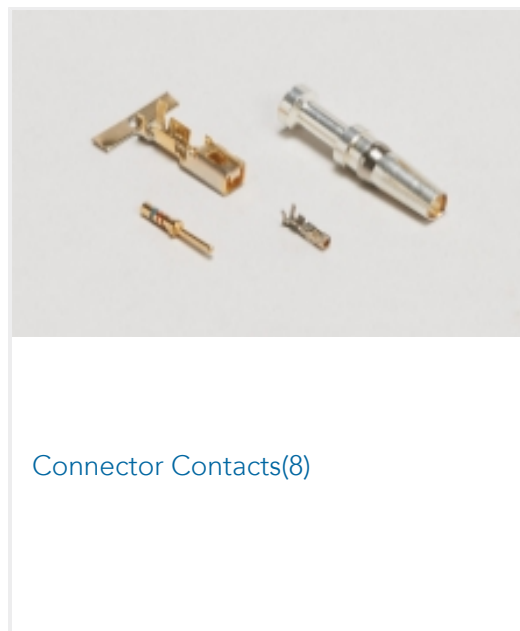

Customers Also Bought

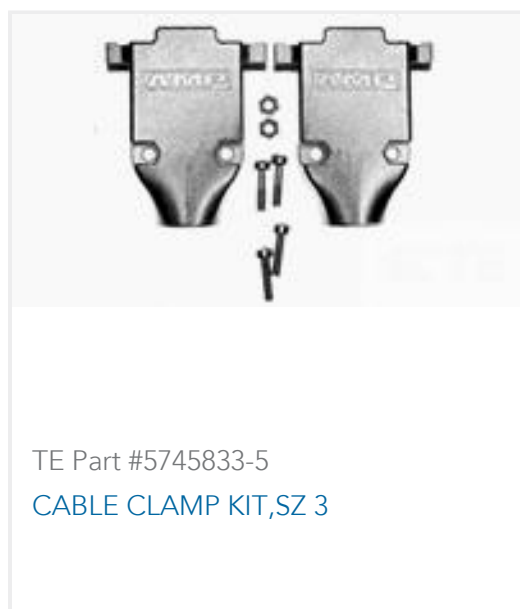
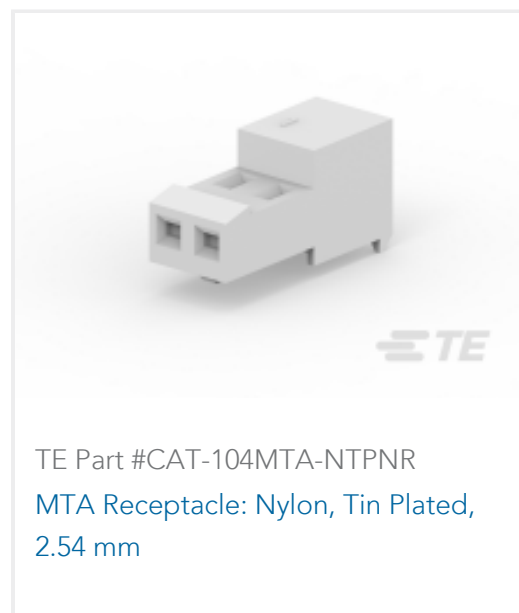
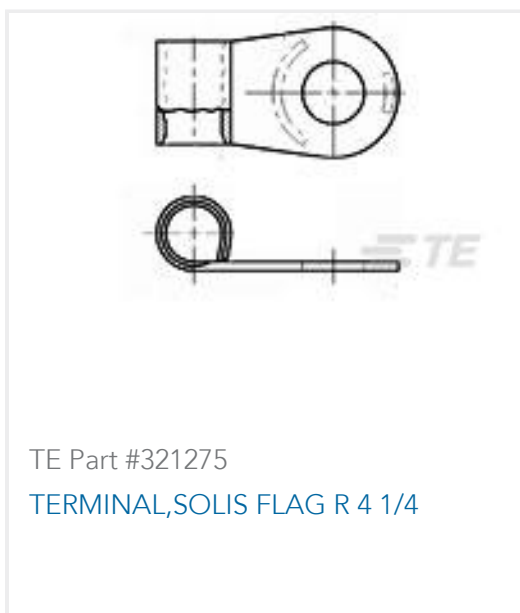



Documents

Product Drawings

[18P MTA100 MOLDED COVER](#)

English

CAD Files

[3D PDF](#)

English

Customer View Model

[ENG_CVM_1-643075-8_G.3d_igs.zip](#)

English

Customer View Model

[ENG_CVM_1-643075-8_G.3d_stp.zip](#)

English

Customer View Model

[ENG_CVM_1-643075-8_G.2d_dxf.zip](#)

English

[3D PDF](#)

3D

Customer View Model

[ENG_CVM_CVM_1-643075-8_N.2d_dxf.zip](#)

English

Customer View Model

[ENG_CVM_CVM_1-643075-8_N.3d_igs.zip](#)

English

Customer View Model

[ENG_CVM_CVM_1-643075-8_N.3d_stp.zip](#)

English

By downloading the CAD file I accept and agree to the [Terms and Conditions](#) of use.

Product Specifications

[Product Specification](#)

English

Instruction Sheets

[Instruction Sheet \(U.S.\)](#)

English