

1-292173-4 ✓ ACTIVE



AMP CT

TE Internal #: 1-292173-4

PCB Mount Header, Right Angle, Wire-to-Board, 4 Position, 2 mm [.079 in] Centerline, Partially Shrouded, Tin (Sn), Surface Mount, AMP CT

[View on TE.com >](#)

Connectors > PCB Connectors > PCB Headers & Receptacles > AMP COMMON TERMINATION HEADERS



PCB Connector Type: **PCB Mount Header**

PCB Mount Orientation: **Right Angle**

Connector System: **Wire-to-Board**

Number of Positions: **4**

Number of Rows: **1**

[All AMP COMMON TERMINATION HEADERS \(33\)](#)

Features

Product Type Features

PCB Connector Type	PCB Mount Header
Connector System	Wire-to-Board
Header Type	Partially Shrouded
Sealable	No
Connector & Contact Terminates To	Printed Circuit Board
Connector Product Type	Connector Assembly

Configuration Features

PCB Mount Orientation	Right Angle
Number of Positions	4
Number of Rows	1

Electrical Characteristics

Operating Voltage	125 VDC
-------------------	---------



Body Features

Primary Product Color	Natural
-----------------------	---------

Contact Features

Mating Pin Diameter	.6 mm[.024 in]
Contact Mating Area Plating Material Thickness	1 – 2 μm[39.37 – 78.73 μin]
PCB Contact Termination Area Plating Material Thickness	1 – 2 μm[39.37 – 78.73 μin]
Contact Shape & Form	Round
Contact Layout	Inline
Contact Mating Area Length	4.2 mm[.165 in]
Contact Base Material	Brass
PCB Contact Termination Area Plating Material	Tin
Contact Mating Area Plating Material	Tin (Sn)
Contact Type	Pin
Contact Current Rating (Max)	4 A

Termination Features

Termination Post & Tail Diameter	.6 mm[.024 in]
Termination Method to PCB	Surface Mount

Mechanical Attachment

Panel Mount Feature	With
Mating Retention	Without
Mating Alignment Type	Polarization
PCB Mount Retention Type	Solder Peg
PCB Mount Retention	With
PCB Mount Alignment	With
Connector Mounting Type	Board Mount
Mating Alignment	With

Housing Features

Housing Material	6T PA GF
Centerline (Pitch)	2 mm[.079 in]

Dimensions

Connector Width	9 mm[.354 in]
PCB Thickness (Recommended)	.8 mm[.031 – .063 in]



Connector Height	5.8 mm[.228 in]
------------------	-----------------

Connector Length	9.8 mm[.386 in]
------------------	-----------------

Usage Conditions

Operating Temperature Range	-40 – 105 °C[-40 – 221 °F]
-----------------------------	----------------------------

Operation/Application

Assembly Process Feature	Pick and Place Cover
--------------------------	----------------------

Circuit Application	Power & Signal
---------------------	----------------

Industry Standards

Compatible With Agency/Standards Products	CSA, UL
---	---------

Compatible With Approved Standards Products	CSA LR7189, UL E28476
---	-----------------------

UL Flammability Rating	UL 94V-0
------------------------	----------

Packaging Features

Packaging Quantity	500
--------------------	-----

Packaging Method	Box, Tape
------------------	-----------

Product Compliance

[For compliance documentation, visit the product page on TE.com>](#)

EU RoHS Directive 2011/65/EU	Compliant
------------------------------	-----------

EU ELV Directive 2000/53/EC	Compliant
-----------------------------	-----------

China RoHS 2 Directive MIIT Order No 32, 2016	No Restricted Materials Above Threshold
---	---

EU REACH Regulation (EC) No. 1907/2006	Current ECHA Candidate List: JAN 2025 (247) Candidate List Declared Against: JUNE 2024 (241) Does not contain REACH SVHC
--	--

Halogen Content	Not Low Halogen - contains Br or Cl > 900 ppm.
-----------------	--

Solder Process Capability	Reflow solder capable to 245°C
---------------------------	--------------------------------

Product Compliance Disclaimer

This information is provided based on reasonable inquiry of our suppliers and represents our current actual knowledge based on the information they provided. This information is subject to change. The part numbers that TE has identified as EU RoHS compliant have a maximum concentration of 0.1% by weight in homogenous materials for lead, hexavalent chromium, mercury, PBB, PBDE, DBP, BBP, DEHP, DIBP, and 0.01% for cadmium, or qualify for an exemption to these limits as defined in the Annexes of Directive 2011/65/EU (RoHS2). Finished electrical and electronic equipment products will be CE marked as required by Directive 2011/65/EU. Components may not be CE marked. Additionally, the part numbers that TE has identified as EU ELV compliant have a maximum concentration of 0.1% by weight in homogenous materials for lead, hexavalent chromium, and mercury, and 0.01% for cadmium, or qualify for an exemption to these limits as defined in the Annexes of Directive 2000/53/EC (ELV). Regarding the REACH Regulation, the information TE provides

on SVHC in articles for this part number is based on the latest European Chemicals Agency (ECHA) 'Guidance on requirements for substances in articles' posted at this URL: <https://echa.europa.eu/guidance-documents/guidance-on-reach>

Compatible Parts



TE Part # CAT-AM7017-C7671
Common Termination Contacts —
POWER TRIPLE LOCK



TE Part # 1-353293-3
MINI CT MT REC ASSY 13P GRAY



TE Part # CAT-AM7017-H8172
AMP COMMON TERMINATION
HOUSINGS

Also in the Series | AMP CT



Connector Contacts(8)

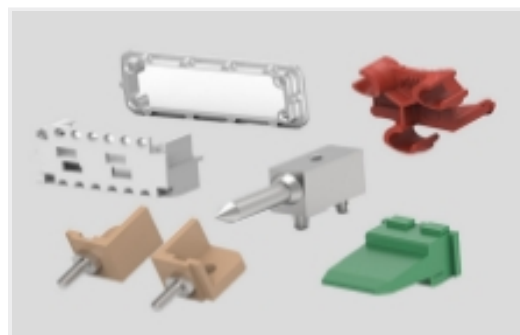

Connector Hardware(46)

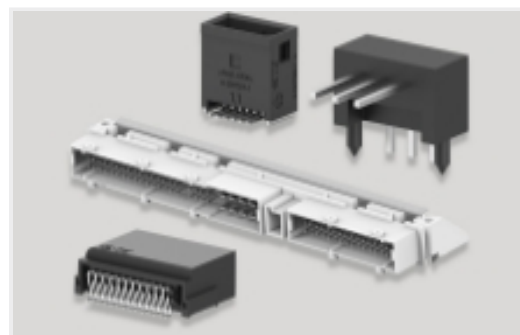

PCB Headers & Receptacles(756)



Rectangular Connector Housings(90)



Rectangular Power Connectors(924)



Standard Rectangular Connectors(176)



Wire-to-Board Connector Assemblies
& Housings(79)

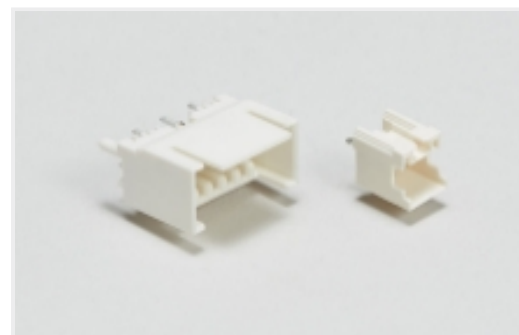

Wire-to-Board Headers & Receptacles
(756)

Customers Also Bought



TE Part #179844-1
AMP POWER D/LOCK T/HDR ASSY 2P

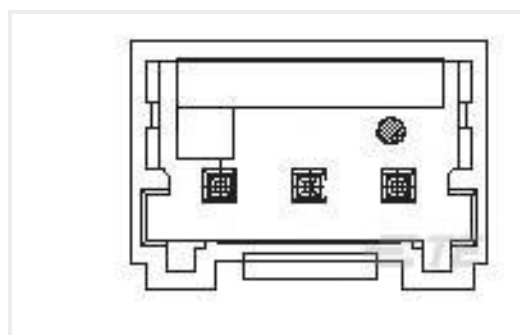

TE Part #1971032-3
3P HEADER ASSEMBLY FOR GIC 2.0
EV



TE Part #1747052-1
GRACE INERTIA CONNECTOR 7.92
2POS_HEADER

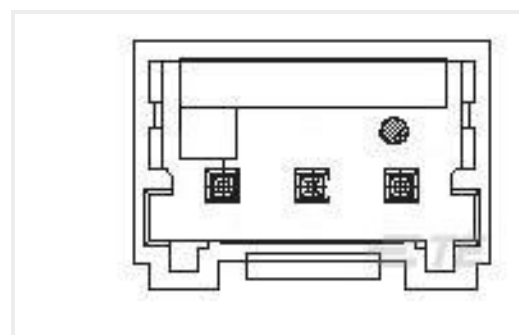

TE Part #1-1971032-8
8POS HEADER ASSEMBLY FOR GIC
2.0 EV

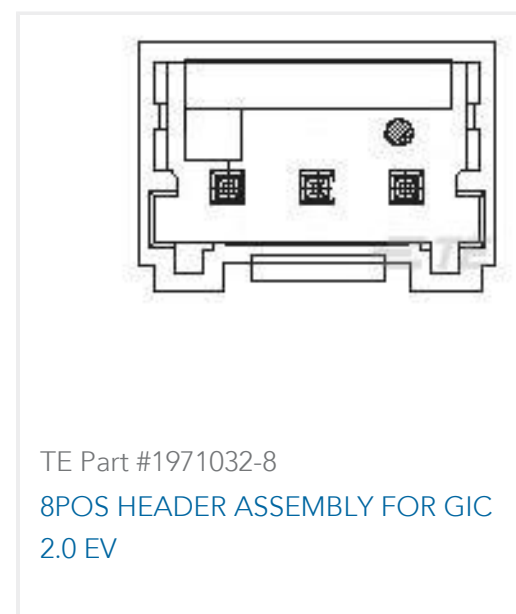
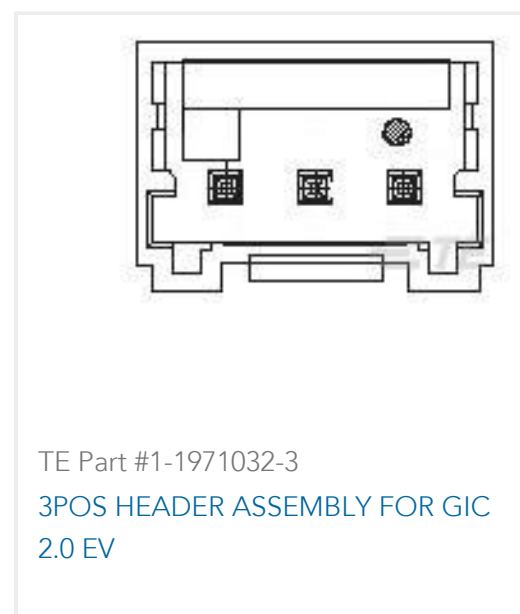

Documents

CAD Files

3D PDF

3D

Customer View Model

[ENG_CVM_CVM_1-292173-4_B1.2d_dxf.zip](#)

English

Customer View Model

[ENG_CVM_CVM_1-292173-4_B1.3d_igs.zip](#)

English

Customer View Model

[ENG_CVM_CVM_1-292173-4_B1.3d_stp.zip](#)

English

By downloading the CAD file I accept and agree to the [Terms and Conditions](#) of use.

Product Specifications

Product Specification

English

AMP COMMON TERMINATION (CT), CONNECTOR, 2mm PITCH, M/T TYPE, LEAD FREE VERSION

Japanese

Product Specification

Japanese

Agency Approvals

CSA Certificate

English

CSA Certificate

English

1-292173-4

PCB Mount Header, Right Angle, Wire-to-Board, 4 Position, 2 mm [.079 in]
Centerline, Partially Shrouded, Tin (Sn), Surface Mount, AMP CT

