

GPS/GLONASS Patch Antenna

1 SCOPE

This specification shall cover the characteristics of the dielectric antenna element with the type ATPG1590R1540A

2 PART NO. : ATPG1590R1540A

3 OUTLINE DRAWING AND DIMENSIONS

3.1 Appearance: No visible damage and dirt.

3.2 The products conform to the RoHS directive and national environment protection law.

3.3 Dimensions

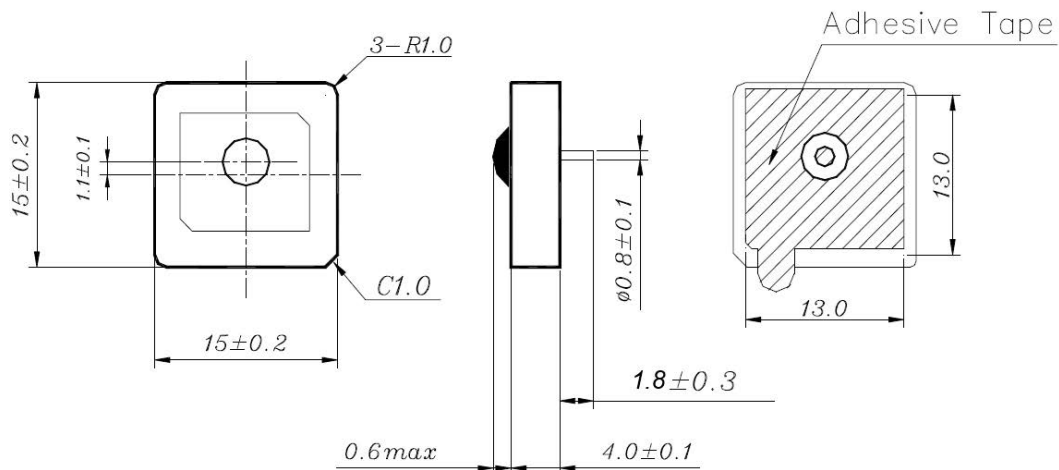

4 ELECTRICAL SPECIFICATIONS

4.1 Performance Characteristics

Items	Content
Nominal frequency MHz	1575~1608
Center frequency MHz	1592 ± 3.0
Return Loss at 1575MHz max dB	-7
Return Loss at 1609MHz max dB	-7
Polarization Model	RHCP
Impedance	50Ω
Frequency Temperature Coefficient	20ppm/deg.°C max

4.2 Impedance Characteristic

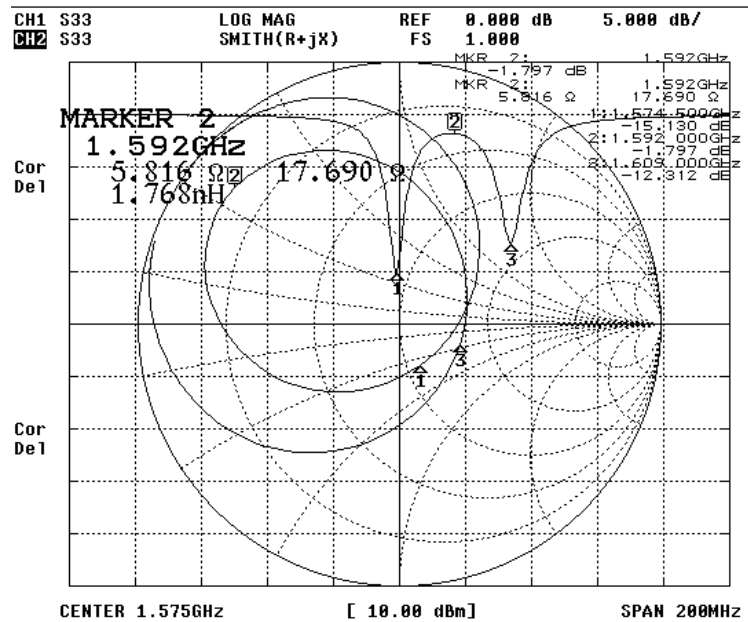

5 TEST

5.1 Test Conditions

Parts shall be measured under a condition (Temp.: $20^{\circ}\text{C}\pm 15^{\circ}\text{C}$, Humidity : $65\%\pm 20\%$ R.H.).

5.2 Test Jig

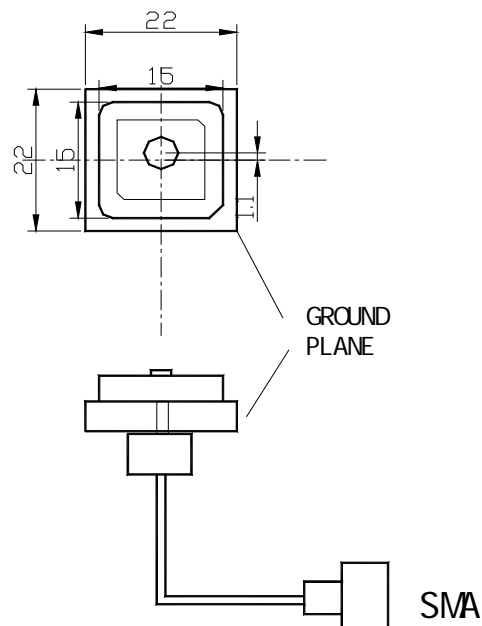

6 ENVIRONMENTAL TEST

No.	Item	Test Condition	Remark
6.1	Humidity Test	The device is subjected to 90%~95% relative humidity $60^{\circ}\text{C} \pm 3^{\circ}\text{C}$ for 96h~98h, then dry out at $25^{\circ}\text{C} \pm 5^{\circ}\text{C}$ and less than 65% relative humidity for 2h~4h. After dry out the device shall satisfy the specification in table 1.	It shall fulfill the specifications in Table 1.
6.2	High Temperature Exposure	The device shall satisfy the specification in table 1 after leaving at 105°C for 96h~98h, provided it would be measured after 2h~4h leaving in $25^{\circ}\text{C} \pm 5^{\circ}\text{C}$ and less than 65% relative humidity.	It shall fulfill the specifications in Table 1.
6.3	Low Temperature	The device shall satisfy the specification in table 1 after leaving at -40°C for 96h~98h, provided it would be measured after 2h~4h leaving in $25^{\circ}\text{C} \pm 5^{\circ}\text{C}$ and less than 65% relative humidity.	It shall fulfill the specifications in Table 1.
6.4	Temperature Cycle	Subject the device to -40°C for 30 min. followed by a high temperature of 105°C for 30 min cycling shall be repeated 5 times. At the room temperature for 1h prior to the measurement.	It shall fulfill the specifications in Table 1.
6.5	Vibration	Subject the device to vibration for 2h each in x、y and z axis with the amplitude of 1.5mm, the frequency shall be varied uniformly between the limits of 10Hz~55Hz.	It shall fulfill the specifications in Table 1.
6.6	Soldering Test	Lead terminals are heated up to $350^{\circ}\text{C} \pm 10^{\circ}\text{C}$ for $5\text{s} \pm 0.5\text{s}$ with brand iron and then element shall be measured after being placed in natural conditions for 1 h. No visible damage and it shall fulfill the specifications in Table 1	It shall fulfill the specifications in Table 1.
6.7	Solder ability	Lead terminals are immersed in soldering bath of $260^{\circ}\text{C} \sim 290^{\circ}\text{C}$ for $3\text{s} \pm 0.5\text{s}$. More than 95% of the terminal surface of the device shall be covered with fresh solder.	The terminals shall be at least 95% covered by solder.
6.8	Terminal Pressure Strength	Force of 2kg is applied to each lead in axial direction for $10\text{s} \pm 1\text{s}$ (see drawing). No visible damage and it shall fulfill the specifications in Fig 1	Mechanical damage such as breaks shall not occur.

FIG 1

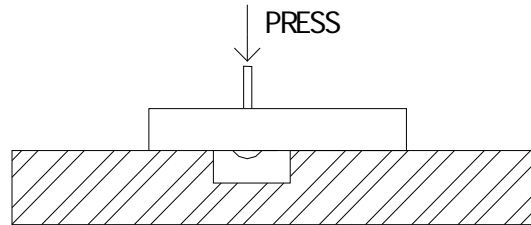

TABLE 1

Item	Specification After Test (MHz)
Center Frequency change	± 2.0

7. OTHER

7.1 Caution of use

7.1.1 Please don't apply excess mechanical stress to the component and terminals at soldering.

7.1.2 The component may be damaged when an excess stress will be applied.

7.1.3 This specification mentions the quality of the component as a single unit. Please insure the component is thoroughly evaluated in your application circuit.

7.2 Notice

7.2.1 Please return one of these specifications after your signature of acceptance.

7.2.2 When something gets doubtful with this specification, we shall jointly work to get an agreement